

PANIGALE V2





Index

| | | | |
|----|--|----|--|
| 4 | Panigale V2. The Ducati twin evolves. | 18 | Chassis: top quality components |
| 6 | Panigale V2 Bayliss 1 st Championship 20 th Anniversary. Born to celebrate. | 21 | Modern and sophisticated technology and electronics |
| 11 | A unique Panigale. Twin-cylinder. Baylisstic. | 25 | Riding Mode: each to their own style |
| 13 | A track-ready Panigale. | 26 | Servicing and maintenance |
| 14 | Ducati Superquadro: efficient on track, smooth and enjoyable on the road | 29 | Technical data and equipment |
| 17 | The integration of a multifunctional frame | 38 | Apparel |
| | | 44 | Accessories |
| | | 50 | Ducati Digital Experience |

Panigale V2. The Ducati twin evolves.

Lightweight, high-performance, fun on the road and a thrill on track: introducing the Panigale V2, the latest successor in a legendary line - a compact superbike, designed and created to offer you Ducati sports DNA in its purest form.

The Panigale twin is not afraid of being compared to its older sisters. Based on a design inspired by the Panigale V4, the updated aesthetics highlight a strong, bold personality. Its beating heart, the 955 cc Superquadro engine with 90° V cylinders, offers smooth delivery during road riding and effectively encourages the pursuit of performance.

Rider-specific ergonomics, a balanced chassis, and sophisticated electronics based on the six-axis inertial platform are all distinctive elements of this bike, always ready to express its full potential. Built to both surprise and excite you, on road and track.

The Panigale V2 is now available in three versions. Firstly, the traditional full Ducati Red colour scheme, paired with black five-spoke Y rims. Then the pure and dynamic White Rosso version, with Ducati Red details on a Star White Silk livery. And, last but not last, the commemorative Bayliss Special Livery, a special version with select Öhlins components that raise track performance to another level, created in homage to the ultimate Ducati hero, Troy Bayliss.





Panigale V2 Bayliss 1st Championship 20th Anniversary. Born to celebrate.

The Panigale V2 Bayliss 1st Championship 20th Anniversary commemorates one of the most successful riders of all time, a man symbolic of an entire community: Troy Bayliss. Produced as a numbered series, this special bike is both Ducati sports DNA in its purest form and a tribute to a timeless passion.

This version of the Panigale V2 stands out for its special livery, inspired by the 996 R with which Bayliss won his first world title in 2001, as well as its select Öhlins components, which raise the track performance of the Panigale V2 Bayliss 1st Championship 20th Anniversary to another level.

With respect to the standard version, this commemorative model is also 3 kg lighter, thanks to the use of a lithium-ion battery and its single-seat configuration, which clearly recalls the set-up of the bike used during the racing season (passenger seat and footpegs included).





A unique Panigale. Twin-cylinder. Baylisstic.

52 wins, 94 podiums and 3 Superbike World Championship titles: the Ducati-Bayliss partnership proved to be one of the most successful in the motorsport universe. The Australian's feats on track left an indelible mark on the hearts of all Ducatisti and now, that unique chemistry between Ducati and "Baylisstic" returns in the form of this commemorative bike, produced in a numbered series, the graphics and name of which have been mutually agreed upon.

Ducati red is adopted as the main colour of the bike, combined with green and white as a tribute to the manufacturer's Italian heart. Standing out on the front and sides is the number 21, Troy Bayliss' iconic race number, and the Shell logo, both of which accentuate the bike's racing character. The tank bears Troy's signature, while the billet aluminium steering plate features the name of the bike and the progressive number of this unique model.

The design of the Panigale V2 Bayliss 1st Championship 20th Anniversary is topped off with sports hand grips, a carbon fibre and titanium silencer [QP1] [LE2] and a rider seat created in technical materials with embroidery and double red stitching, which incorporates the number 21 and the colours of the Italian flag.





A track-ready Panigale.

As well as its special livery, the racing soul of the Panigale V2 Bayliss 1st Championship 20th Anniversary is also highlighted with select Öhlins components. The fork and rear shock ensure the utmost smoothness and are designed to offer the best possible performance on track, with a set-up that makes the bike more precise and provides the rider with greater feeling and support during all phases of the ride. The steering damper offers various adjustments so that calibration can be personalised to suit riding style and track characteristics.

Ducati Superquadro: efficient on track, smooth and enjoyable on the road

The 955 cc Superquadro twin, the heart of the new Panigale V2, conforms with Euro 5 standards. With respect to the engine of the 959 Panigale, it delivers an extra 5 hp and 2 Nm of torque, and is paired with a new silencer, the compact and integrated design of which is fully contained beneath the engine.

With its 155 hp at 10,750 rpm and 104 Nm of torque at 9000 rpm, the twin is enjoyable and smooth in its delivery on the road, just as it is efficient on track without ever creating any difficulty for the rider.

The increase in performance is primarily linked to the new injectors, two per cylinder, which are larger and re-angled, and the new snorkel which, delivery rates remaining equal, loses less pressure than its predecessor, thus boosting intake efficiency.

The new 2-1-1 silencer features an internal layout that more easily abates spikes in noise, thus allowing for a considerable reduction in bulk. The new silencer also houses a larger and more efficient catalytic convertor.

The engine of the Panigale V2 acts as a stressed member of the frame, its cylinders positioned at 90° and banked rearwards around the axis of the crankshaft to achieve a 21° angle between the front cylinder and the horizontal plane. The Superquadro uses brass bushings for the crankshaft, lubricated via dedicated channels inside the crankcase. This ensures efficient lubrication of the crankshaft and rapid oil recovery thanks to a lobe pump that - as on MotoGP racing engines - lowers the pressure in the connecting rod casing.

The compression ratio is 12.5:1 and the 955cc engine size is achieved with a 60.8 mm stroke and a 100 mm bore, measurements that ensure the perfect combination of effective handling and fluid power delivery. A 100 mm bore allows for significant valve diameters: 41.8 mm for the intake and 34 mm for the exhaust. The valves are controlled by a Desmodromic system with racing-derived rocker arms, 'super-finished' and complete with special DLC (Diamond-like Carbon) coating to reduce friction and increase fatigue strength.

Transmission involves a six-speed gearbox with the Ducati Quick Shift up/down EVO 2 system and an oil bath clutch. The latter has a progressive self-servo mechanism that compresses the friction plates when under drive from the engine without any extra effort required from the rider to release the clutch.



In sports riding conditions, characterised by aggressive shifting and engine brake transfer, the same mechanism reduces pressure on the clutch discs, allowing them to work in the racing-derived anti-wheelie mode, which obstructs any locking of the rear wheel and subsequent loss of rear stability during aggressive braking, while offering the additional advantage of excellent modulation when braking.



The integration of a multifunctional frame

The Panigale V2 frame comprises a monocoque structure, in die-cast aluminium to increase its strength, that uses the Superquadro engine as a stressed member.

The frame is directly attached to the cylinder heads and protrudes forwards to house the steering head bearings. As well as carrying out the traditional frame function, the monocoque also serves as an air-box, housing not only the air filter, but also the throttle bodies and fuel circuit, complete with injectors.

With this frame, the front-end geometry has a rake of 24°, and 95 mm trail. At the rear is a sophisticated, fully die-cast aluminium single-sided swingarm. The bike has a 1436 mm wheelbase and weight distribution is 52% at the front and 48% at the rear.



Chassis: top quality components

Suspension

The new Panigale V2 mounts a 43 mm Showa BPF fork at the front, fully adjustable in terms of spring pre-load, compression and rebound damping. Rear suspension involves a fully adjustable Sachs shock that reacts to movements transmitted by the single-sided swingarm with progressive linkage. With respect to the suspension of the 959 Panigale, the Panigale V2 has 2 mm fork slide out and a new shock absorber that is 2 mm longer. Together with the new Pirelli Diablo Rosso Corsa II tyres, this makes for a bike that is more intuitive, agile and fun to ride. The hydraulic brakes have also been fine-tuned to increase comfort during road use.

Wheels and tyres

The Panigale V2 has a five-spoke, 3.5-inch wheel at the front and a 5.5-inch wheel at the rear, and mounts Pirelli Diablo Rosso Corsa II tyres, 120/70 ZR17 at the front and 180/60 x ZR17 at the rear. The Diablo Rosso Corsa II is the first

Pirelli multi-compound motorcycle tyre, fruit of technology developed in the Superbike World Championship that adopts areas with different compounds at the front and rear to optimise the contact area between the tyre and the asphalt, ensuring maximum grip in all conditions and at all lean angles, on both road and track and in both wet and dry conditions. A new tread pattern with a slick shoulder zone optimises the contact patch and ensures more even wear. Aspect ratio and structure are also racing-derived and designed to maximise cornering agility and 'feel'.

Braking system

The Panigale V2 is equipped with a front braking system that comprises twin Brembo M4.32 monobloc callipers activated by a radial master cylinder. Discs are 320 mm in diameter. At the rear, the Borgo Panigale sports bike mounts a single 245 mm disc gripped by a single Brembo calliper.

Ergonomics

The ergonomics of the Panigale V2 have been updated to improve overall comfort. The new seat allows for greater longitudinal rider movement and greater comfort when seated, thanks to new foam.





Modern and sophisticated technology and electronics

The new Panigale V2 is equipped with modern, sophisticated electronics, based on the use of the 6-axis IMU that can instantly identify the bike's role, yaw and pitch angle in space.

ABS Bosch Cornering EVO

Complete with "cornering" functioning that allows for ABS intervention even with the bike leaned over, the ABS system has three levels to meet the needs of all riders, even in critical situations where grip is poor. Level 3 is intended for the road or in conditions of poor grip, ensuring safe and stable braking, while levels 2 and 1 prioritise braking power and are more sports-orientated, for riding on high-grip surfaces or on track.

Ducati Traction Control (DTC) EVO 2

The Traction Control is based on an algorithm that makes for fast and precise intervention.

In addition to interfacing with the 6-axis Inertial Measurement Unit (IMU) and adapting intervention depending on wheelspin and lean angle, the EVO 2 software significantly improves corner

exit power control thanks to a new 'predictive' strategy. Acting not just on the basis of instantaneous rear wheelspin but also its variation, it intercepts any loss of grip sooner and reduces peak wheelspin, ensuring faster, smoother intervention. All this means augmented corner exit ability (even in sub-optimal grip conditions), as well as greater acceleration and improved performance over both a flying lap and a long run.

Ducati Wheelie Control (DWC) EVO

Wheelie Control uses the data feed from the 6D IMU to keep wheelies in check while maximising acceleration easily and safely.

Ducati Quick Shift up/down (DQS) EVO 2

The Quick Shift up/down, now also with downshift function, exploits lean angle data to maximise bike stability when shifting gears through the turns. The DQS EVO 2 reduces up-shift times, allowing those sportier high-rev gear shifts (over 9000 rpm) typical of track

riding, and boosts shift stability during aggressive acceleration and cornering.

Engine Brake Control (EBC) EVO

The EBC (Engine Brake Control) has been refined to help riders optimise bike stability in extreme turn-in conditions, balancing the forces applied to the rear tyre under severe engine brake conditions.

Ducati Data Analyser+ with GPS module (DDA+)

The Ducati Data Analyser+ GPS allows for the evaluation of bike and rider performance by showing traces for specific data channels. The DDA+ is available as a Ducati Performance plug-and-play accessory.

Ducati Lap Timer GPS (DLT GPS)

The DLT GPS feature automatically records and saves lap times and displays them directly on the dashboard each time the bike crosses the finish line, the coordinates of which are set by pressing the flasher button. If a lap time is the best of the current track session, the Best Lap function causes it to flash for

5 seconds. For every lap, and for a total of 30 consecutive laps, the DLT GPS records lap time, maximum rpm, maximum speed and lean/yaw angles. The information can be displayed on the screen via the relative menu. DLT GPS is available as a Ducati Performance plug-and-play accessory.



Instrumentation and light systems.

The instrumentation is based around a 4.3" TFT display with graphics and interface inspired by those of the Panigale V4. The Riding Mode interface clearly and immediately shows any changes being made to the settings. This is done thanks to the explanatory graphics of the system being adjusted and a graduated scale indicating whether the modification is better suited to performance or safety/stability.

The front headlight assembly is extremely compact thanks to the adoption of two small LED low beam/high beam modules. The Daytime Running Light and V-shaped upper rim of the dual headlight assembly create a 'browed' look, the modern hallmark of Ducati sports bikes.

At the rear, the full LED taillight is functionally divided into two parts, in line with Ducati sports tradition. The dual red arch of the side light makes the Panigale V2 both unique and assertive.





Riding Modes: each to their own riding style

The three Riding Modes available on the new Panigale V2 allow the rider to choose between different pre-set riding styles for behaviour that perfectly suits the rider, type of road surface, and weather conditions. Each Riding Mode is programmed to instantaneously alter both the character of the engine and electronic control parameters.

Race Riding Mode: allows less experienced riders to enjoy top-end bike performance on high-grip track surfaces. Selecting Race gives the rider 155 hp, with direct Ride by Wire throttle response. Race mode sets the electronics at a low intervention level but without compromising safety, with ABS set to level 2, lift-up control off and the 'slide by brake' function (which lets riders drift the bike into the corners safely) on. It is also possible to activate ABS level 1 (only recommended for expert riders on track) that only intervenes at the front wheel, without activating the corner and lift-up control functions, for maximum braking performance.

Sport Riding Mode: selecting Sport gives the rider 155 hp, with direct sports-style Ride by Wire throttle response. Electronic controls are set to give riders perfect dry road ride responsiveness. Rear wheel lift detection during braking is on, as is the Cornering function to maximise cornering performance.

Street Riding Mode: Street mode is recommended when riding on surfaces with poor grip. This mode provides riders with 155 hp and progressive Ride by Wire throttle response. The predefined electronic control settings ensure grip and stability to maximise safety.

Servicing and maintenance

Safety as standard

Ducati's continuing commitment to design, research and development has the precise objective of guaranteeing state-of-the-art motorcycles characterised by the highest degree of active safety. It is with racing performance in mind and a view to increasing the level of control during the most difficult riding that we continue to develop systems that are always at the cutting edge.

The ABS Bosch Cornering EVO on the Panigale V2 controls every moment of braking even when the bike is leaning, which is when the Engine Brake Control EVO system kicks in to fine-tune the braking torque. The acceleration stage is controlled by Ducati Traction Control EVO, Ducati Wheelie Control EVO and Ducati Slide Control. These systems allow the rider to enjoy, in complete safety, the maximum performance of a sport bike belonging to the most powerful series ever built by Ducati.

More value to your passion

With Ever Red, the quality and reliability of the Ducati brand remain your inseparable travelling companions over time. Ever Red is the exclusive Ducati warranty extension programme. With its activation you can continue to feel protected for 12 or 24 months beyond the expiration of the Ducati Warranty (24 months). Ever Red includes roadside assistance for the entire coverage period and no mileage limits. In this way you can ride for all the kilometres you want, even abroad, enjoying your Ducati without any worries.

To find out if the Ever Red extension is available in your country and for further information contact your Ducati dealer or visit ducati.com.

Endless excitement

In designing each bike, Ducati constantly strives to ensure maximum reliability while reducing service costs. A commitment that has seen the intervals for the main Desmo Service, in which valve clearance is checked and adjusted if necessary, extended to 24,000 km (15,000 mi) for the Panigale V2. Even the simplest of checks, such as the Oil Service, are extended to 12,000 km (7,500 mi) or 12 months.

A considerable interval for such high-performance engines, which only confirms the high quality standards adopted in terms of material selection and R&D processes. Ducati continuously invests in the technical training of its dealers. The specific skills offered by the official Ducati Service network ensure that all those operations needed to keep every Ducati in perfect condition are thoroughly executed, while advanced equipment such as the Ducati Diagnosis System allows the software on each Ducati to be updated with the latest releases, ensuring that the electronics continue to perform at the maximum level.

Always by your side

One of Ducati's main goals is to offer every Ducatista the chance to enjoy unlimited and safe travel all over the world. To achieve this aim, Ducati offers a "fast delivery" original spares service, with delivery in 24/48 hours across 85% of the areas in which it operates. With a distribution network that covers more than 91 countries, thanks to 738 official Dealers and Service Points*, choosing a Ducati means you can travel worry free and in total freedom, wherever the road may take you, and count on support from our extensive Dealer network that ensures Ducati quality and professionalism is always close at hand.

738 Authorised dealers and service points

91 World countries

*Information updated as of February 2021



Ever Red
Extended Warranty



*Equal to 18,000 miles.



Technical data and equipment



PANIGALE V2

Dimensions

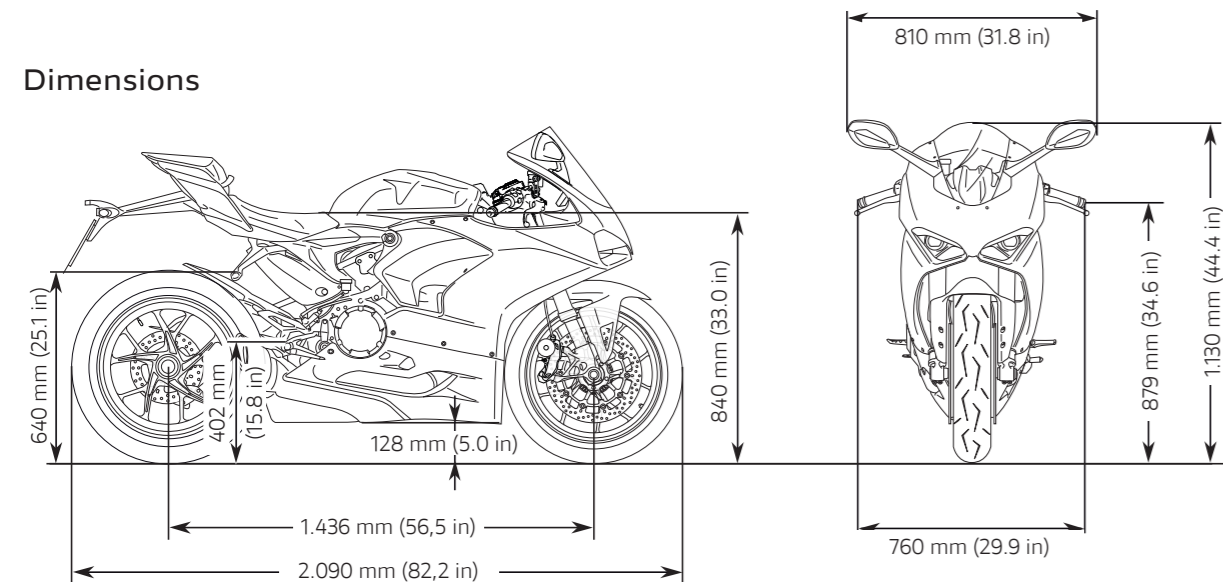

Curve di torque / power

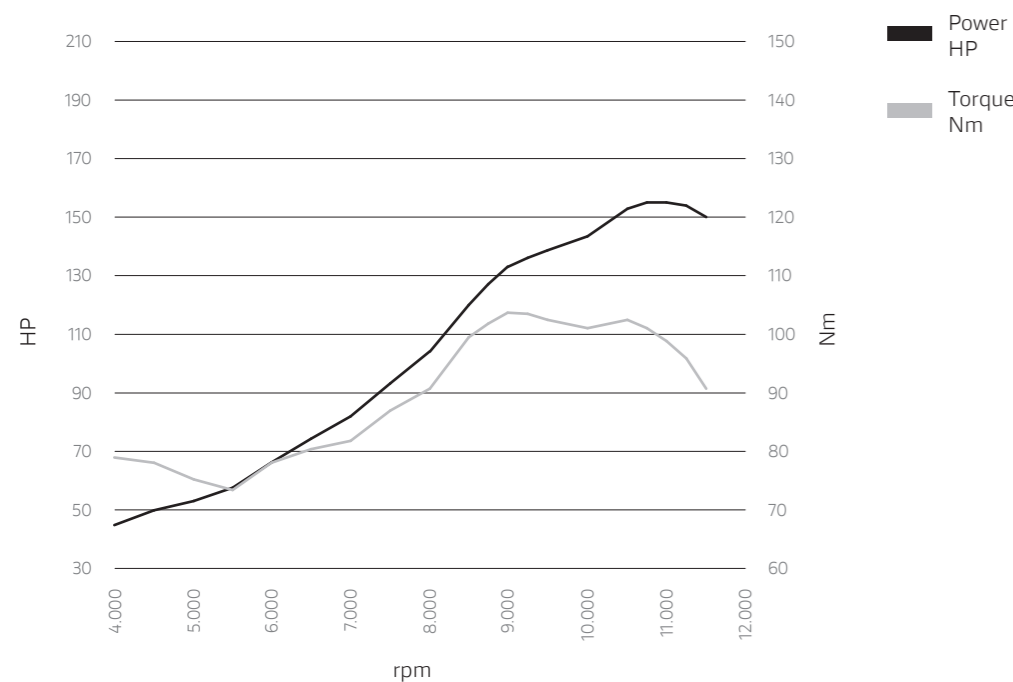

Engine

Engine Superquadro: L-twin cylinder, 4 valve per cylinder, Desmodromic, liquid cooled

Displacement 955 cc

Bore X stroke 100 x 60,8 mm (3.4 x 2.4 in)

Compression ratio 12.5:1

Power 155 HP (114 kW) @ 10,750 rpm

Torque 76.7 lb-ft (104 Nm) @ 9,000 rpm

Fuel injection Electronic fuel injection system. Twin injectors per cylinder. Full ride-by-wire elliptical throttle bodies

Exhaust 2-1-2-1 system, with 2 catalytic converters and 2 lambda probes

Transmission

Gearbox 6 speed with Ducati Quick Shift (DQS) up/down EVO 2

Primary drive Straight cut gears; Ratio 1.77:1

Ratio 1=37/15 2=30/16 3=27/18 4=25/20 5=24/22 6=23/24

Final drive Chain; Front sprocket 15; Rear sprocket 43

Clutch Hydraulically controlled slipper and self-servo wet multiplate clutch

Chassis

Frame Monocoque Aluminium

Front suspension Fully adjustable Showa BPF fork. 43 mm chromed inner tubes

Front wheel 5-spokes light alloy 3.50" x 17"

Front tyre Pirelli Diablo Rosso Corsa II 120/70 ZR17

Rear Suspension Fully adjustable Sachs unit. Aluminum single-sided swingarm

Rear Wheel 5-spokes light alloy 5.50" x 17"

Rear tyre Pirelli Diablo Rosso Corsa II 180/60 ZR17

Wheel travel (front/rear) 120 mm (4.72 in) - 130 mm (5.12 in)

Front brake 2 x 320 mm semi-floating discs, radially mounted Brembo Monobloc M4.32 4-piston callipers with Bosch Cornering ABS EVO

Rear brake 245 mm disc, 2-piston calliper with Bosch Cornering ABS EVO

Instrumentation Digital unit with 4.3" TFT colour display

Dimensions and Weights

Dry weight / ABS version 176 kg (388 lb)

Kerb weight / ABS version 200 kg (441 lb)

Seat height 840 mm (33.1 in)

Wheelbase 1.436 mm (56.5 in)

Rake 24°

Front wheel trail 94 mm (3.70 in)

Fuel tank capacity 17 l - 4.5 gallon (US)

Number of seats Dual seat

Safety equipment

Riding Modes, Power Modes, Bosch Cornering ABS EVO, Ducati Traction Control (DTC) EVO 2, Ducati Wheelie Control (DWC) EVO, Engine Brake Control (EBC) EVO, Auto tyre calibration

Standard equipment

Ducati Quick Shift (DQS) up/down EVO 2, Full LED lighting with Daytime Running Light (DRL), Sachs steering damper, Auto-off indicators

Ready for

Ducati Data Analyser+ (DDA+) with GPS module, Ducati Multimedia System (DMS) and anti-theft

Warranty

Warranty (months) 24 months unlimited mileage

Maintenance (km/months) 12,000 km (7,500 m)/12 months

Controllo gioco valvole (km) 24,000 km (15,000 m)

Emissions and Consumptions

Standard Euro 5* - Emissions CO2 = 139 g/km - Consumptions 6,0 l/100km

* Only for countries where Euro 5 standard applies



** equal to 18,000 miles.

Kilometres refer to the first Desmo Service, i.e. when the valve clearance is checked and adjusted if necessary.

PANIGALE V2



| | Panigale V2 | Panigale V2 Bayliss 1 ST Championship 20 TH Anniversary |
|---|--|--|
| Machined from solid steering head with bike name and progressive number | - | ✓ |
| Seat in technical fabric | - | ✓ |
| Carbon fibre silencer outlet cover | - | ✓ |
| Sports hand grips | - | ✓ |
| Single-seater configuration* | - | ✓ |
| Front suspension | Fully adjustable 43 mm USD Showa BPF fork in chrome-plated steel | Fully adjustable 43 mm USD Öhlins NIX30 fork with TiN treatment |
| Rear suspension | Fully adjustable Sachs shock | Fully adjustable Öhlins TTX36 shock |
| Steering damper | Sachs | Adjustable Öhlins |
| Lithium battery | - | ✓ |
| Dry weight | 176 kg (388 lb) | 174,5 kg (385 lb) |
| Kerb weight | 200 kg (441 lb) | 197 kg (434 lb) |

*: The bike is homologated as a two-seater; passenger seat and footpegs are included.



1 Öhlins shock



2 Adjustable Öhlins steering damper



3 Seat in technical fabric

PANIGALE V2

Ducati Red



White Rosso livery



PANIGALE V2

Bayliss 1st Championship 20th Anniversary livery



Bayliss
2001
2006
2008
21

Apparel



Ducati Corse K1 Racing suit. Speed Evo Full-face helmet.

Ducati Apparel Collection designed by *Drudi Performance*



From left. Ducati Corse JD Jair® C2 Racing suit with airbag system. Ducati Corse Speed 2 Full-face helmet. Ducati Corse C5 Racing suit. Ducati Corse V5 Full-face helmet. Ducati Corse K1 Racing suit. Speed Evo Full-face helmet.



From left to the top. Ducati Corse Leather gloves. Ducati Corse Speed 2 Full-face helmet. Ducati Corse C5 Racing suit.

Ducati Corse V5 Air Racing Boots



From top left. DC Track cap. V4 Eyes t-shirt. DC Track sweatshirt. Ducati Corse Sketch t-shirt. DC Track short-sleeved polo shirt. Bottom. Dovizioso sunglasses. DC Track t-shirt.



DC Tonal t-shirt. Acapulco sunglasses.



From left. Dovizioso sunglasses. DC Track t-shirt. Racing Spirit cap. Acapulco sunglasses. DC Tonal t-shirt. Racing Spirit t-shirt.

ACCESSORIES

Configure the Ducati of your dreams.

Sporty and elegant, various accessories have been created to further heighten the riding pleasure.

Panigale V2 Sport accessories package. Exclusive details to highlight the bike's strong racing spirit. The carbon of the licence plate holder blends with the billet aluminium of the handlebar counterweights, the fuel cap and the brake and clutch levers to further enhance the overall look. Dynamic LED turn signals, lightweight and compact, complete the exclusive kit and enhance the rear design.

Extremely high-quality materials to ensure durability and high performance. An elegant design that perfectly marries with the lines of the bike, for an even more unmistakable style. The perfect combination of accessories for a look that is sheer adrenaline.

Configure. Choose the ideal Panigale V2 for you and have fun configuring it to suit your riding style! Share it with friends and send it to your Ducati dealer who will contact you for an online consultation to discuss the current offers that best suit your needs.

Save your configuration to return to it at any time.

Calculate your payment

Ducati Financial Services offers favourable solutions for the financing of every model in the Ducati range. Personalise your financing and calculate the monthly instalments. You can then contact your dealer and discuss the best way to see your dream come true!



Go to configurator

For more information about the Ducati Performance range, tech specs and instructions, refer to a Ducati dealer or visit the Accessories section of ducati.com



1 Carbon heel guard. Adjustable rider footpegs in aluminium.

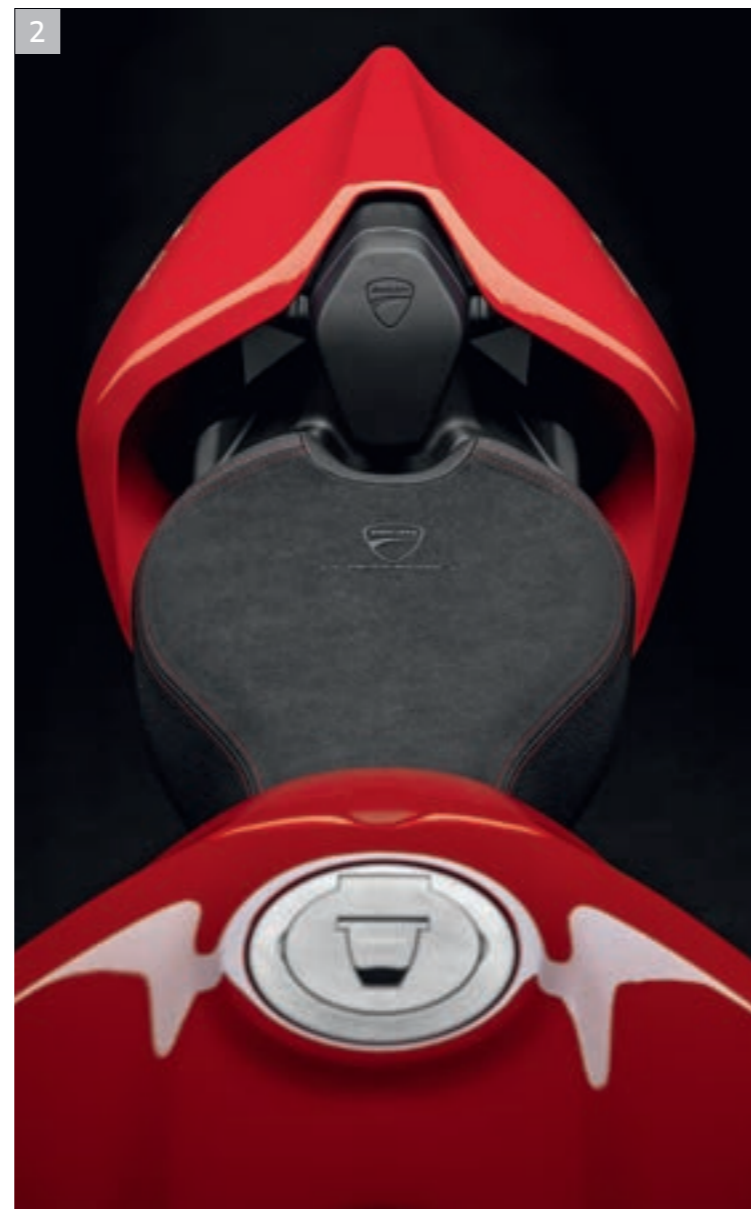

2 Racing seat in technical fabric.



3 Carbon cover for clutch case.



4 Billet aluminium handlebar balancing weights.



5 Brake fluid reservoir. Clutch fluid reservoir.



1



2

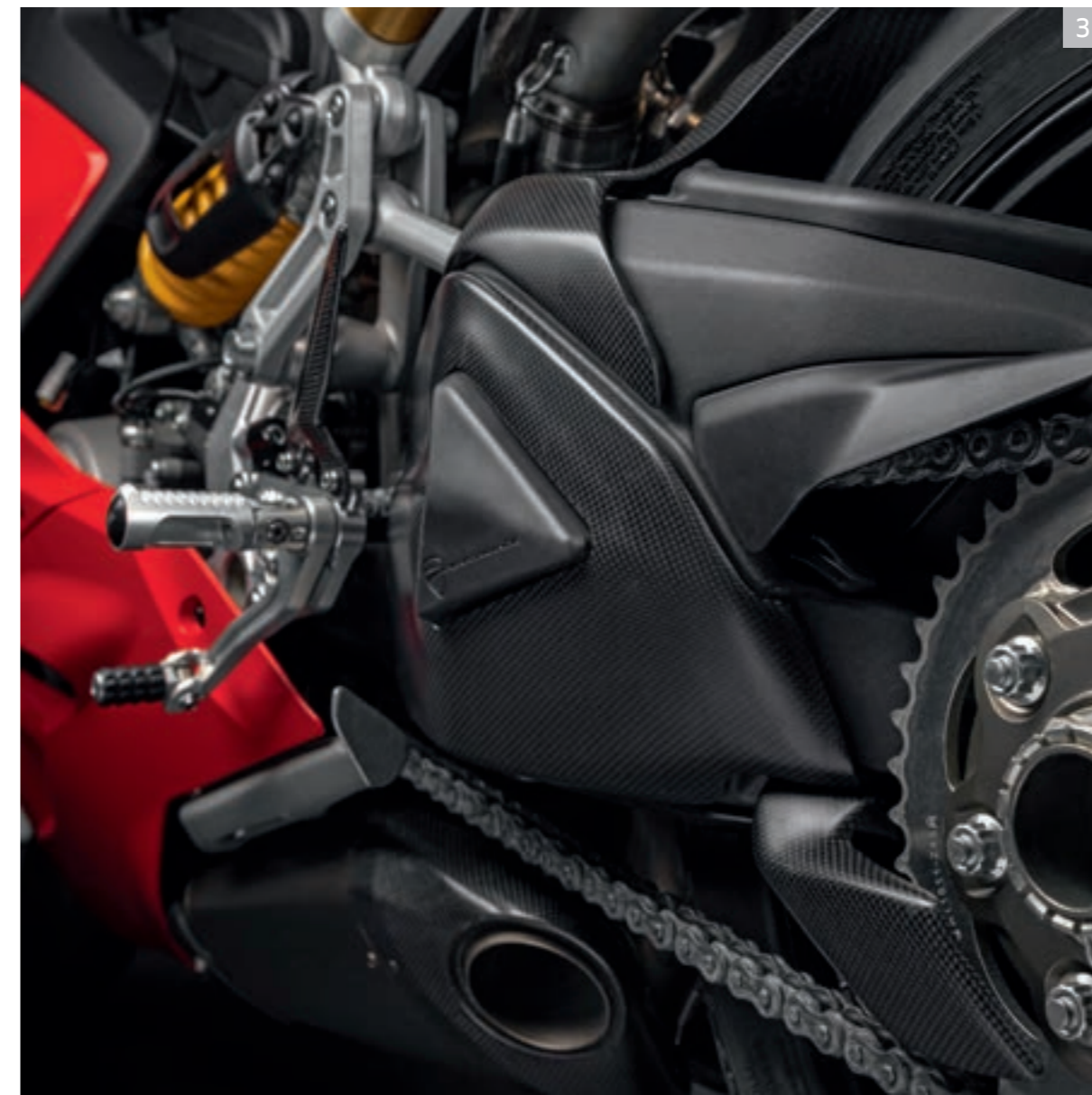

3



4



5

1 Carbon front mudguard.



2 Carbon cover for rear shock absorber.



3 Carbon swingarm guard.



4 Carbon rear mudguard.









5 Carbon number plate holder. Pair of LED turn indicators.



Ducati Digital Experience

A mission for every channel. Continuous updating on the innovation and passion for which our work stands out. We transform emotions into exclusive content. Just a click away.

Follow us on:

-  www.ducati.com
-  [@ducati](https://www.instagram.com/ducati)
-  [@DucatiMotor](https://twitter.com/DucatiMotor)
-  [Ducati Motor Holding](https://www.linkedin.com/company/ducati-motor-holding)
-  [@ducati](https://www.facebook.com/ducati)
-  [Ducati Motor Holding](https://www.youtube.com/DucatiMotorHolding)
-  [@ducati_official](https://www.tiktok.com/@ducati_official)

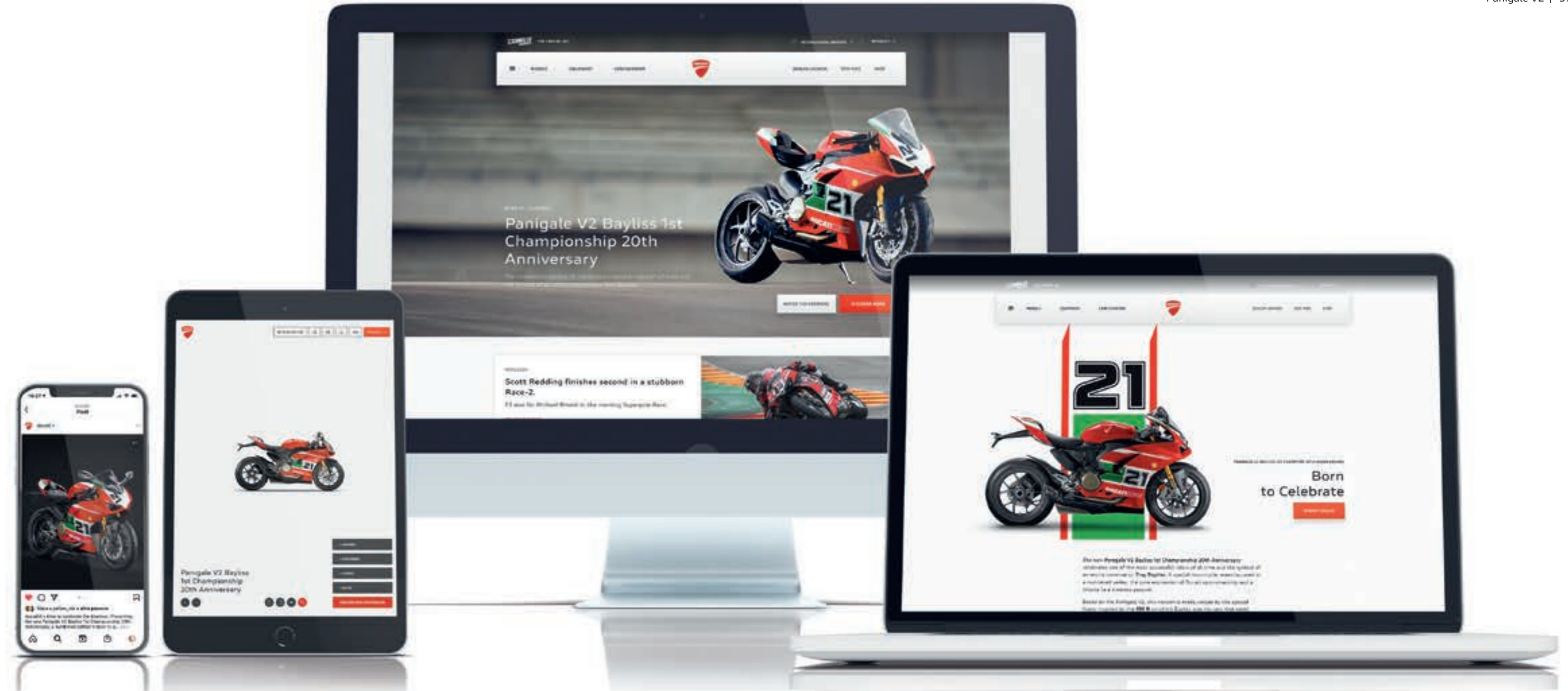

Key to symbols

 This product is designed exclusively for race bikes ridden on a closed racetrack. Its use on public roads is forbidden by law.

 This accessory is not approved for road circulation.

 Anodized

 Matt

 This accessory is approved for road circulation in Europe.

Riding a motorcycle is the most exciting way to enjoy the road, and offering the utmost safety to the motorcyclist is Ducati's commitment. Ducati bikes are increasingly easy to handle, reliable and better equipped to guarantee maximum safety and enhance riding pleasure. Technical clothing is made with more and more advanced materials for adequate protection and increased visibility. The safety of motorcyclists is Ducati's commitment. For more information visit the safety section of the Ducati site (www.ducati.com).

WARNING: The photos and technical information in this catalogue may refer to prototypes subject to modifications during production and are purely for illustration and reference purposes, and are therefore not binding on Ducati Motor Holding S.p.A. Sole Shareholder Company - Company subject to the direction and coordination of AUDI AG ("Ducati"). Ducati cannot be held responsible for any print and/or translation errors. This catalogue is transnational and therefore some products may not be available and/or their features may vary in accordance with local laws. Not all colours and versions are available in each country. Ducati reserves the right to make changes and improvements to any product without obligation of prior notice or to make such changes to products already sold. Further characteristics of the products are contained in the pertinent owner's manuals.



ducati.com

The products represented are not definitive versions and are therefore subject to significant changes at Ducati's discretion without prior notice. The photographs published in this catalogue show only professional riders under controlled street conditions. Do not attempt to imitate such riding behaviour as it could be dangerous for you or other people on the road. This catalogue, including but not limited to the trademarks, logos, texts, images, graphics and table of contents herein, constitute Ducati intellectual property, or in any event Ducati has the right to reproduce it; any reproduction, modification or other whole or partial use of the catalogue or its contents, including publication on the Internet without the prior written consent of Ducati, is prohibited.

Actual fuel consumption may vary based on many factors, including but not limited to riding style, maintenance performed, weather conditions, surface characteristics, tyre pressure, load, weight of the rider and the passenger, accessories.

Ducati indicates the dry weight of the motorcycle excluding battery, lubricants and coolants for liquid-cooled models. The weights in running order are considered with all operating fluids and the fuel tank filled to 100% of its useful capacity (Regulation (EU) no. 168/2013). For more information visit www.ducati.com.

September 2021.



